

## V-LANE A2B

### 2MP@60fps 250 Km/h (1 Corsia)

- 1 Lanes coverage
- Infrared + color (bispectral) single head camera
- Plate reading up to 250 km/h in free-run
- Integrated IR illuminator with stroboscopic LEDs
- 2 Mpixel resolution (context + OCR)
- OCR library on board with 41 countries in Europe, 13 Asia, 6 Africa, 5 South America and special plates such as Trailers, Kemler ADR, Kemler ADR Empty, Tram
- Daytime classification of vehicles by type in 13 + 1 (Cars, Semitrucks, Trucks, Trucks with trailers, Motor vehicles, Motorcycles, Mopeds, Buses, Coach, Mini vans, Big vans, Flatbed trucks, Caravans, unknown)
- Night classification of vehicles by type in 4 classes +1 (trucks, buses, cars, motorcycles and unknown)
- Daytime classification of vehicles by color in 11 classes + 1 (black, white, grey, red, blue, yellow, green, orange, pink, purple, cyan, unknown)
- Vehicle brand classification (around 100 brands supported)
- Model classification of vehicles in transit - Rear view (about 400 models supported)
- Gate AID algorithms for traffic control (stationary vehicle, wrong-way vehicle, slow traffic, queue)
- Transit speed estimation function
- Black & White lists
- ONVIF Profile S
- Local NVR function for storage continuous recording of camera video streaming and creation of micro movies on vehicle transits
- Cloud ready
- Compatible with the Vigilate v-SUITE general supervision platform
- Certified high reliability, the library has been validated several times by UNI 10772:2016 class A for all vehicle classes



### DESCRIPTIONS

**Analysis and recognition** v-LANE A2B is the 2Mpixels intelligent camera able to control and manage all the problems of a road gate both for safety aspects and for aspects relating to traffic control. V-LANE A2B detects 60 images per second within which it analyzes, identifies and validates the license plates of the vehicles present. This result obtained through the use of sophisticated software makes it possible to read the license plate of vehicles in transit at speeds of up to 250 km/h in free-run mode (without an external trigger device).

**Data** Data and images can be stored directly locally, sent to the customer's supervision system or sent to the v-SUITE supervision platform. The device has FTP, XML-RPC (on HTTPS) and serial transmission protocols. Software Optical Character Recognition (OCR) library complete with 41 countries in Europe, 13 Asia, 6 Africa, 5 South America and special plates such as Trailers, Kemler ADR, Kemler ADR Empty, Trams (Police, Army, Ambulance, Civil Protection...).

**Classification** The camera is equipped with a video classification software capable of recognizing vehicle types with 13 + 1 (Cars, Semitrucks, Trucks, Trucks with trailers, Motor vehicles, Motorcycles, Mopeds, Buses, Coach, Mini vans, Big vans, Flatbed trucks, Caravans, unknown); it is also able to identify the dominant color among a range of 11 colors + 1 (black, white, gray, red, blue, yellow, green, orange, pink, purple, cyan, unknown). v-Lane is equipped with gate AID algorithms for traffic control (stationary vehicle, wrong-way vehicle, slow traffic, queue).

**Data security** The storage and transmission of data generated by the product takes place using highly reliable and secure protocols, guaranteeing the highest level of inviolability and privacy. Vigilate complies with the most restrictive regulations on data security such as ISO27001:2022 and ISDP10003:2018 - Privacy by Default and Privacy by Design.

**Application examples** Access control for public and private car parks Territorial and traffic control Access control for residential areas Tolling systems



## TECHNICAL FEATURES

### Optical group

Sensor (OCR + COLOR)	2 MP (1920 x 1080) CMOS COLOR + IR (bispectral) global shutter sensor
Frame rate	Up to 60 fps
Optics	Standard varifocal lens, 8-50 mm

### Illuminator

Integrated IR illuminator	n. 8 LED IR (CLASS 1M CEI EN 69825-1 ED. 4, 850 nm IR LED)
---------------------------	--

### HW features

Processor	Quad-core + HW video encoder unit + Neural coprocessor
Memory	16 GB e-MMC Flash
RAM	4 GB
S.O.	Linux
Storage Disk	HD SSD 128 GB (up to 2 TB)

I/O	N. 2 input opto-isolated N. 1 output relè N. 1 fast output strobo 12-24 VDC N. 1 output open-collector 12-24 VDC
-----	---

Ports	N.1 USB port N.1 RS-485 port N.1 10/100/1000 Mbps Ethernet port
-------	---

### SW features

Operating mode	Continuously acquisition (free-run) On request (by SW trigger or HW trigger) Both modes can draw on the two local lists that can be configured locally or by remote synchronization with the FTP server
----------------	---

Real-time diagnostics	CPU temperature Mainboard temperature IR illumination module operation Lighting module current peaks Capture status of physically connected sensors Input current level (power port) Input voltage level (power port) Camera tilt angle Internal humidity level CPU consumption RAM consumption Storage disks status Utilization of the 4 physical cores (CPU monitoring) Check status of operational threads Monitoring of analysis times and operating status of active algorithms Generation of any alarms (local and possibly remote) in the face of anomalies detected
-----------------------	--

Supported sending protocols	TCP (in binary, XML, string formats) TCP Milestone FTP (imgs + text data in *.txt/*.csv) RPC-XML over HTTP / HTTPS (BASIC or EXTENDED message) Custom Protocol (message configurable via template and sendable by HTTP POST / HTTPS POST / TCP protocols) Serial (on RS 485 port) Wiegand (need to install SC20 converter) Xentinel message (over HTTP) v-SUITE message (over HTTP / HTTPS)
-----------------------------	---

Supported communication protocols	TCP/IP UDP HTTP HTTPS FTP FTPS RTP/RTSP openVPN ONVIF (S- profile) NTP SNMP
-----------------------------------	---

Data protection	Possibility to activate the management of the web configurator by HTTPS connection FTPS encryption on TLS/SSL protocol AES-256-ECB encryption for data and images saved locally and/or sent via the supported protocols Image hash using SHA-512 algorithm and possible encryption of the signature itself using AES-256-ECB Totally GDPR compliant storage management with periodic deletion of the history Cockpit masking function (in case of front detection of vehicles) in order to ensure respect for privacy Possibility to connect the camera inside an openVPN with certificate installed directly on board Advanced management of the firewall on the machine with the possibility of disabling access to the local servers present on the machine (FTP server, ONVIF server, SNMP server, service ports)
-----------------	--

Si prega di notare che i dati tecnici, le informazioni, e le immagini contenute nel presente documento sono solo di riferimento. Vigilate si riserva il diritto di modificare in qualsiasi momento e senza preavviso i dati, i disegni e le informazioni qui contenute.  
Please note that the technical data, information and images contained herein shall be for reference only. Vigilate reserves the right to modify at any time and without notice the data, drawing and the information contained herein.

V-22072025-1616-1-UPD

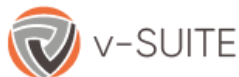

Vigilate - PSIM  
(Physical Security Information Management)





### Power Supply

Supported power supply	24VDC (2,5 A) or +12VDC (5 A) or UPoE 60W class 6
Consumption	12W typically

### General characteristics

Dimensions	450 x 140 x 150 mm
Weight	2,6 Kg
Operating temperature	- 30°; +60°
Humidity	Up to 90%
Protection	IP67 - class IK10 (on request)

### Certifications

OCR library:	Certified high reliability, the library has been validated several times by UNI 10772:2016 class A for all vehicle classes
Classification algorithms:	The percentages of correct classification depend on compliance with the installation geometry but are above 90% regardless of the external environmental conditions
AID algorithm:	The instantaneous speed estimation by video analysis and consequently the AID algorithm with the various supported features are highly reliable as demonstrated by numerous field tests in the presence of approved systems for speed estimation for sanctioning purposes.

### Regulations

Regulations complied with	EN 55032:2015, EN 55035:2017, EN 50561-1:2013 EN 62368-1 (EN 62368-1:2014+A11:2017) EN 60068-2-14:Nb 2011-11 EN 60068-2-78:2013-11 EN 62471:2010 EN60529:1991+A1:2000+A2:2013 UE Regulation 2016/679 (GDPR)
---------------------------	---











### OPTIONALS

- Storage disk capacity extension up to 4TB
- Fixed optics
- GPS module
- Wifi module
- Model Classification License



MADE IN ITALY

**OPTIONALS**

OTRA09	HD SSD M2 500GB per v-LANE serie AxB - AxDx - AxDxHP	
OTRA20	Docker kit per v-LANE serie AxB - AxDx - AxDxHP	
OTRA06	Collare da palo per v-LANE serie AxB - AxDx	
OTRA12	Modulo wiegand per v-LANE serie AxB e AxDx eccetto A0B	
OTRA11	Antenna GPS esterna per v-LANE serie AxB - AxDx - AxDxHP	
OTRA10	HD SSD M2 1TB per v-LANE serie AxB - AxDx - AxDxHP	
OTRA23	Kit semaforo rosso per v-LANE serie AxDx - AxDxHP	
OTRA22	Canone annuale manutenzione per licenza riconoscimento modello veicolo	
OTRA21	Licenza riconoscimento modello veicolo per v-LANE serie AxB - AxDx - AxDxHP	
OTRA02	Radar Doppler 60GHz per v-LANE serie AxB e AxDx	
OTRA01	Illuminatore esteso per v-LANE serie AxB e AxDx	

Si prega di notare che i dati tecnici, le informazioni, e le immagini contenute nel presente documento sono solo di riferimento. Vigilate si riserva il diritto di modificare in qualsiasi momento e senza preavviso i dati, i disegni e le informazioni qui contenute.  
Please note that the technical data, information and images contained herein shall be for reference only. Vigilate reserves the right to modify at any time and without notice the data, drawing and the information contained herein.

V-22072025-1616-3-UPD

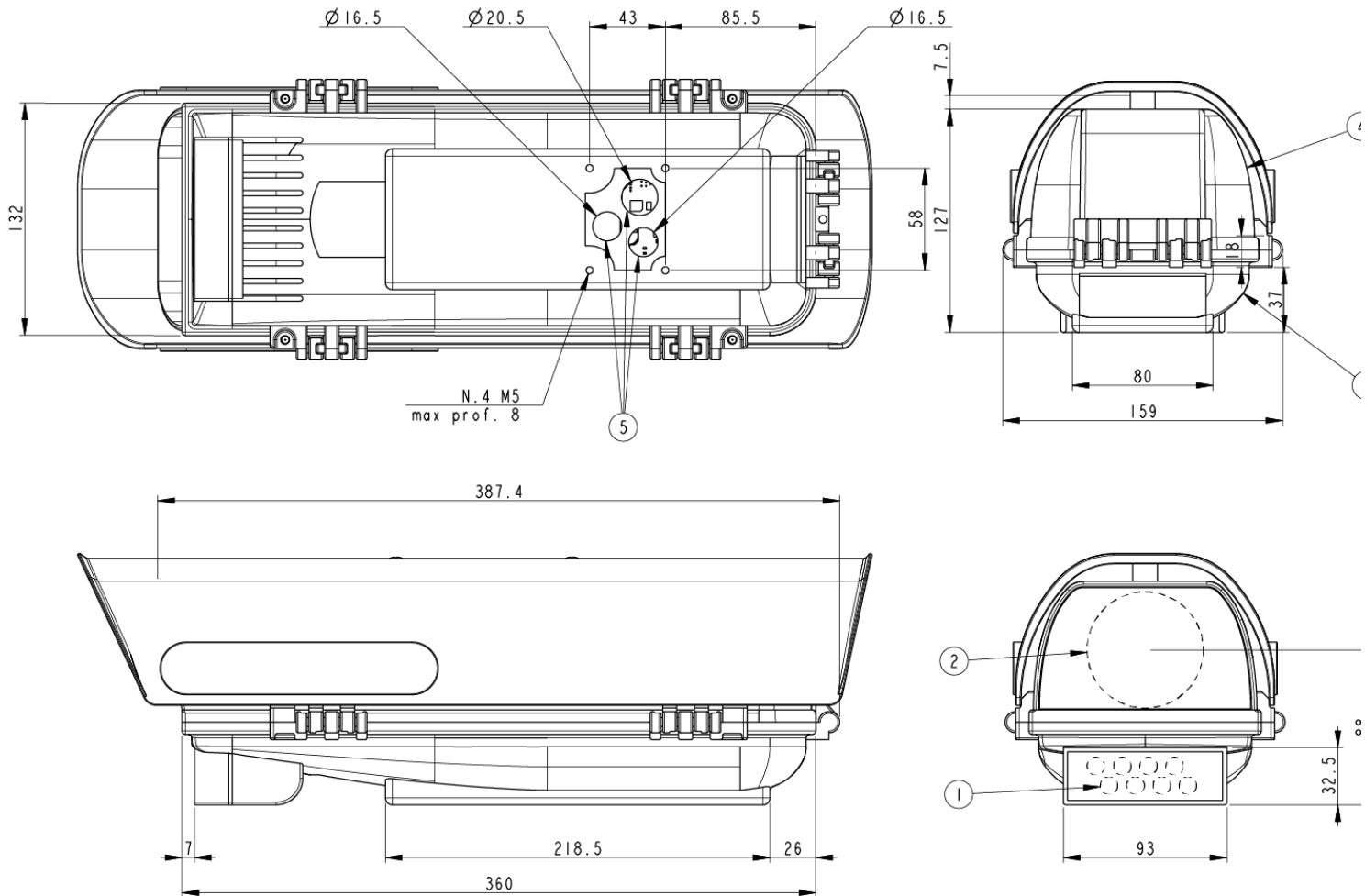

5	Fori passaggio cavi
4	Chiusura custodia verniciata
3	Base custodia verniciata
2	Obiettivo
1	Lenti illuminatore
POS.	DENOMINAZIONE

Si prega di notare che i dati tecnici, le informazioni, e le immagini contenute nel presente documento sono solo di riferimento. Vigilate si riserva il diritto di modificare in qualsiasi momento e senza preavviso i dati, i disegni e le informazioni qui contenute.  
Please note that the technical data, information and images contained herein shall be for reference only. Vigilate reserves the right to modify at any time and without notice the data, drawing and the information contained herein.

V-22072025-1616-4-UPD