

## V-LANE A5D5

5/5MP@75/75fps Multifunctional 250Km/h (2 Lanes)

- 2 Lanes coverage
- OCR + COLOR double head camera
- Plate reading up to 250 km/h in free-run
- Integrated IR illuminator with stroboscopic LEDs
- 5 Mpixel OCR camera resolution
- OCR library on board with 41 countries in Europe, 13 Asia, 6 Africa, 5 South America and special plates such as Trailers, Kemler ADR, Kemler ADR Empty, Tram
- Daytime classification of vehicles by type in 11 + 1 (Cars, Trucks, Trucks with trailers, Motor vehicles, Motorcycles, Mopeds, Buses, Mini vans, Big vans, Flatbed trucks, Caravans, unknown)
- Night classification of vehicles by type in 4 classes +1 (trucks, buses, cars, motorcycles and unknown)
- Daytime classification of vehicles by color in 11 classes + 1 (black, white, grey, red, blue, yellow, green, orange, pink, purple, cyan, unknown)
- Vehicle brand classification (around 100 brands supported)
- Model classification of vehicles in transit - Rear view (about 400 models supported)
- Gate AID algorithms for traffic control (stationary vehicle, wrong-way vehicle, slow traffic, queue)
- Transit speed estimation function
- Black & White lists
- ONVIF Profile S
- Local NVR function for storage continuous recording of camera video streaming and creation of micro movies on vehicle transits
- Cloud ready
- Compatible with the Vigilate v-SUITE general supervision platform
- UNI 10772:2016 Class A certified camera - 7 meters road width, 2 lanes, front and rear number plates, motorcycles, up to 30° side slip



### DESCRIPTIONS

**Analysis and recognition** v-LANE A5D5 is the 5Mpixel OCR - 5 Mpixel context double-headed intelligent camera, able to control and manage all the problems of a road gate both for safety aspects and for aspects relating to traffic control. V-LANE A5D5 detects 75 images per second within which it analyzes, identifies and validates the license plates of the vehicles present. This result obtained through the use of sophisticated software makes it possible to read the license plate of vehicles in transit at speeds of up to 250 km/h in free-run mode (without an external trigger device).

**Data** Data and images can be stored directly locally, sent to the customer's supervision system or sent to the v-SUITE supervision platform. The device has FTP, XML-RPC (on HTTPS) and serial transmission protocols. Software Optical Character Recognition (OCR) library complete with 41 countries in Europe, 13 Asia, 6 Africa, 5 South America and special plates such as Trailers, Kemler ADR, Kemler ADR Empty, Trams (Police, Army, Ambulance, Civil Protection...).

**Classification** The camera is equipped with a video classification software capable of recognizing vehicle types with 11 + 1 classes including (Cars, Trucks, Trucks with trailers, Motor vehicles, Motorcycles, Mopeds, Buses, Mini vans, Big vans, Box bodies, Caravan, unknown); it is also able to identify the dominant color among a range of 11 colors + 1 (black, white, gray, red, blue, yellow, green, orange, pink, purple, cyan, unknown). v-Lane is equipped with gate AID algorithms for traffic control (stationary vehicle, wrong-way vehicle, slow traffic, queue).

**Data security** The storage and transmission of data generated by the product takes place using highly reliable and secure protocols, guaranteeing the highest level of inviolability and privacy. Vigilate complies with the most restrictive regulations on data security such as ISO27001:2022 and ISDP10003:2018 - Privacy by Default and Privacy by Design.

**Application examples** Highway control and high-traffic streets Territorial and traffic control Tolling systems



## TECHNICAL FEATURES

### Optical group

OCR Sensor	5 MP (2560 x 1936) CMOS COLOR + IR (bispectral) global shutter sensor
Frame rate OCR	Up to 75 fps
Color Sensor	5 MP (2560 x 1936) CMOS COLOR rolling shutter sensor
Frame rate color	Up to 75 fps
Optics	Standard varifocal lens, 10-50 mm

### Illuminator

Integrated IR illuminator	n. 8 LED IR (CLASS 1M CEI EN 69825-1 ED. 4, 850 nm IR LED)
---------------------------	--

### HW features

Processor	Quad-core + HW video encoder unit + Neural coprocessor
Memory	16 GB e-MMC Flash
RAM	4 GB
S.O.	Linux
Storage Disk	HD SSD 128 GB (up to 2 TB)
I/O	N. 2 input opto-isolated N. 1 output relè N. 1 fast output strobo 12-24 VDC N. 1 output open-collector 12-24 VDC
Ports	N.1 USB port N.1 RS-485 port N.1 10/100/1000 Mbps Ethernet port

### SW features

Operating mode	Continuously acquisition (free-run) On request (by SW trigger or HW trigger) Both modes can draw on the two local lists that can be configured locally or by remote synchronization with the FTP server
Real-time diagnostics	CPU temperature Mainboard temperature IR illumination module operation Lighting module current peaks Capture status of physically connected sensors Input current level (power port) Input voltage level (power port) Camera tilt angle Internal humidity level CPU consumption RAM consumption Storage disks status Utilization of the 4 physical cores (CPU monitoring) Check status of operational threads Monitoring of analysis times and operating status of active algorithms Generation of any alarms (local and possibly remote) in the face of anomalies detected

### Supported sending protocols

TCP (in binary, XML, string formats)
TCP Milestone
FTP (imgs + text data in *.txt/*.csv)
RPC-XML over HTTP / HTTPS (BASIC or EXTENDED message)
Custom Protocol (message configurable via template and sendable by HTTP POST / HTTPS POST /TCP protocols)
Serial (on RS 485 port)
Wiegand (need to install SC20 converter)
Xentinel message (over HTTP)
v-SUITE message (over HTTP / HTTPS)

### Supported communication protocols

TCP/IP
UDP
HTTP
HTTPS
FTP
FTPS
RTP/RTSP
openVPN
ONVIF (S- profile)
NTP
SNMP

### Data protection

Possibility to activate the management of the web configurator by HTTPS connection
FTPS encryption on TLS/SSL protocol
AES-256-ECB encryption for data and images saved locally and/or sent via the supported protocols
Image hash using SHA-512 algorithm and possible encryption of the signature itself using AES-256-ECB
Totally GDPR compliant storage management with periodic deletion of the history
Cockpit masking function (in case of front detection of vehicles) in order to ensure respect for privacy

Si prega di notare che i dati tecnici, le informazioni, e le immagini contenute nel presente documento sono solo di riferimento. Vigilate si riserva il diritto di modificare in qualsiasi momento e senza preavviso i dati, i disegni e le informazioni qui contenute.  
Please note that the technical data, information and images contained herein shall be for reference only. Vigilate reserves the right to modify at any time and without notice the data, drawing and the information contained herein.

V-15072025-1508-1-UPD



Vigilate - PSIM  
(Physical Security Information Management)



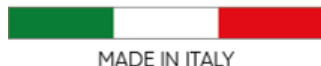

Possibility to connect the camera inside an openVPN with certificate installed directly on board  
Advanced management of the firewall on the machine with the possibility of disabling access to the local servers present on the machine (FTP server, ONVIF server, SNMP server, service ports)

### Power Supply

<b>Supported power supply</b>	24VDC (2,5 A) or +12VDC (5 A) or UPoE 60W class 6
<b>Consumption</b>	12W typically

### General characteristics

<b>Dimensions</b>	450 x 140 x 150 mm
<b>Weight</b>	2,6 Kg
<b>Operating temperature</b>	- 30°; +60°
<b>Humidity</b>	Up to 90%
<b>Protection</b>	IP67 - class IK10 (on request)

### Certifications

<b>OCR library:</b>	UNI 10772:2016 Class A certified camera - 7 meters road width, 2 lanes, front and rear number plates, motorcycles, up to 30° side slip
<b>Classification algorithms:</b>	The percentages of correct classification depend on compliance with the installation geometry but are above 90% regardless of the external environmental conditions
<b>AID algorithm:</b>	The instantaneous speed estimation by video analysis and consequently the AID algorithm with the various supported features are highly reliable as demonstrated by numerous field tests in the presence of approved systems for speed estimation for sanctioning purposes.







### Regulations

<b>Regulations complied with</b>	EN 55032:2015, EN 55035:2017, EN 50561-1:2013 EN 62368-1 (EN 62368-1:2014+A11:2017) EN 60068-2-14:Nb 2011-11 EN 60068-2-78:2013-11 EN 62471:2010 EN60529:1991+A1:2000+A2:2013 UE Regulation 2016/679 (GDPR)
----------------------------------	---

### OPTIONALS

- Storage disk capacity extension up to 4TB
- Fixed optics
- GPS module
- Wifi module
- Model Classification License
- Version with Global shutter in context

**OPTIONALS**

OTRA09	HD SSD M2 500GB per v-LANE serie AxB - AxDx - AxDxHP	
OTRA12	Modulo wiegand per v-LANE serie AxB e AxDx eccetto A0B	
OTRA11	Antenna GPS esterna per v-LANE serie AxB - AxDx - AxDxHP	
OTRA10	HD SSD M2 1TB per v-LANE serie AxB - AxDx - AxDxHP	
OTRA02	Radar Doppler 60GHz per v-LANE serie AxB e AxDx	
OTRA01	Illuminatore esteso per v-LANE serie AxB e AxDx	

Si prega di notare che i dati tecnici, le informazioni, e le immagini contenute nel presente documento sono solo di riferimento. Vigilate si riserva il diritto di modificare in qualsiasi momento e senza preavviso i dati, i disegni e le informazioni qui contenute.  
Please note that the technical data, information and images contained herein shall be for reference only. Vigilate reserves the right to modify at any time and without notice the data, drawing and the information contained herein.

V-15072025-1508-3-UPD

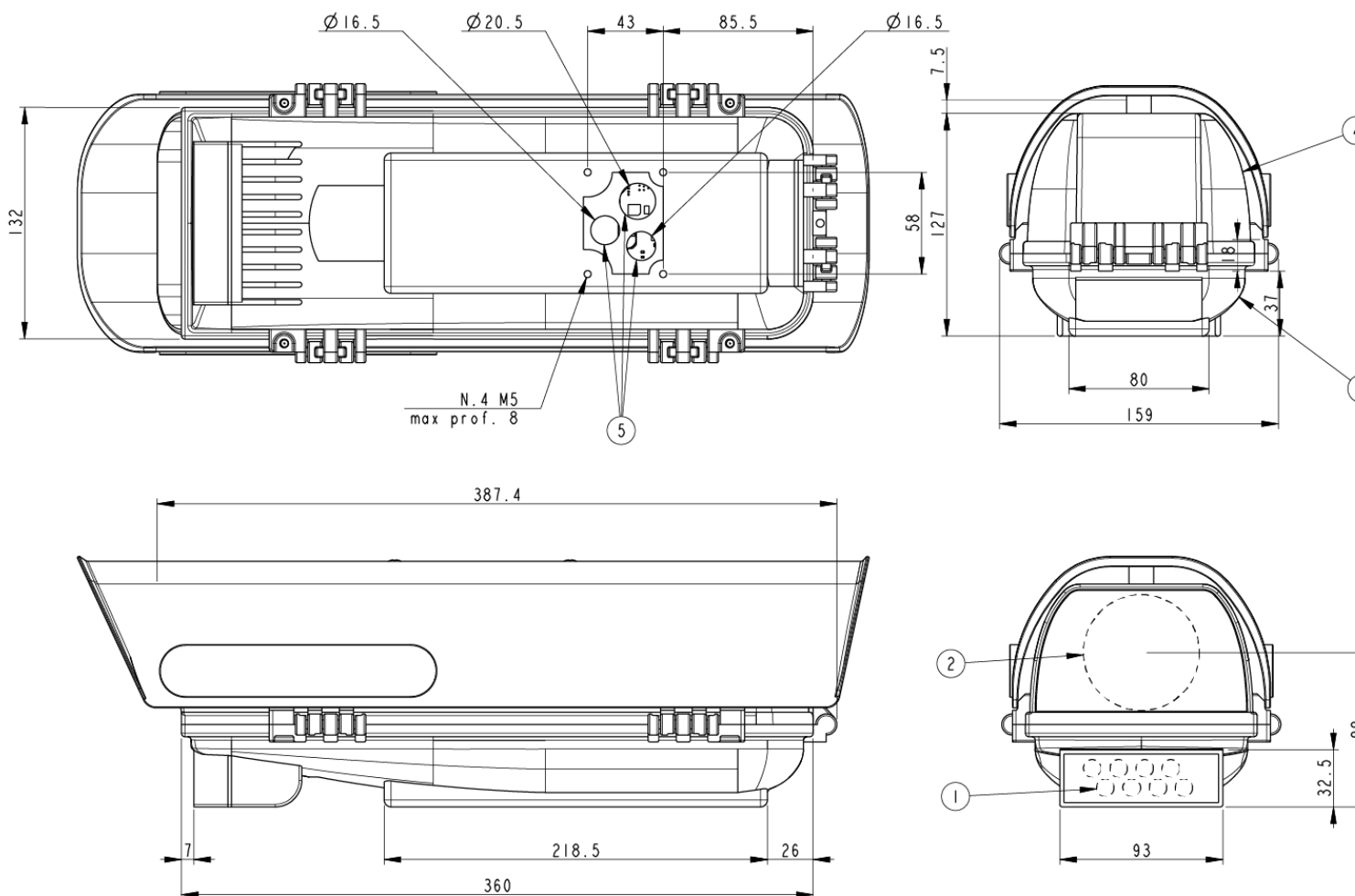

5	Fori passaggio cavi
4	Chiusura custodia verniciata
3	Base custodia verniciata
2	Obiettivo
1	Lenti illuminatore
POS.	DENOMINAZIONE

Si prega di notare che i dati tecnici, le informazioni, e le immagini contenute nel presente documento sono solo di riferimento. Vigilate si riserva il diritto di modificare in qualsiasi momento e senza preavviso i dati, i disegni e le informazioni qui contenute.  
Please note that the technical data, information and images contained herein shall be for reference only. Vigilate reserves the right to modify at any time and without notice the data, drawing and the information contained herein.

V-15072025-1508-4-UPD